



3-Channel Headset Microphone EMI Filter with ESD Protection

CSPEMI205G

Features

- Three channels of EMI filtering, two for earpiece speakers and one for a microphone
- Pi-style EMI filters in a capacitor-resistor-capacitor (C-R-C) network
- Chip Scale Package features extremely low parasitic inductance for optimum filter performance
- Greater than 30dB relative attenuation in the 800-2700MHz range
- ± 8 kV ESD protection on each channel (IEC 61000-4-2 Level 4, contact discharge)
- ± 15 kV ESD protection on each channel (HBM)
- 8-bump, 1.41mm X 1.430mm footprint Chip Scale Package (CSP)
- RoHS compliant (lead-free) finishing

Applications

- EMI filtering and ESD protection for headset microphone and speaker
- Cellular / Mobile Phones
- Notebooks and Personal Computers
- Handheld PCs / PDAs / Tablets
- Wireless Handsets
- Digital Camcorders

Product Description

The CSPEMI205G is a low-pass filter array integrating three pi-style filters (C-R-C) that reduce EMI/RFI emissions while at the same time providing ESD protection. This device is custom-designed to interface with the headset port on a cellular telephone, and contains two different filter values. Each high quality filter provides more than 30dB attenuation in the 800-2700 MHz range. These pi-style filters support bidirectional filtering, controlling EMI both to and from the microphone and speaker elements. They also support bipolar signals, enabling audio signals to pass through without distortion.

In addition, the CSPEMI205G provides a very high level of protection for sensitive electronic components that may be subject to electrostatic discharge (ESD). The input pins safely dissipate ESD strikes of ± 8 kV, the maximum requirement of the IEC 61000-4-2 international standard. Using the MIL-STD-883 (Method 3015) specification for Human Body Model (HBM) ESD, the device provides protection for contact discharges to greater than ± 15 kV.

The CSPEMI205G is particularly well suited for portable electronics (e.g., cellular telephones, PDAs, notebook computers) because of its small package format and low weight. The CSPEMI205G is available in a space-saving, low-profile Chip Scale Package with RoHS compliant lead-free finishing.

Electrical Schematic

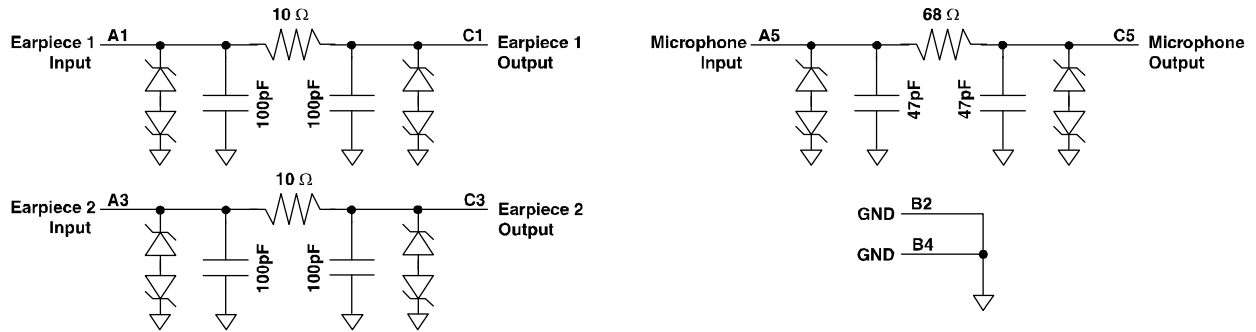

PACKAGE / PINOUT DIAGRAMS

TOP VIEW
(Bumps Down View)

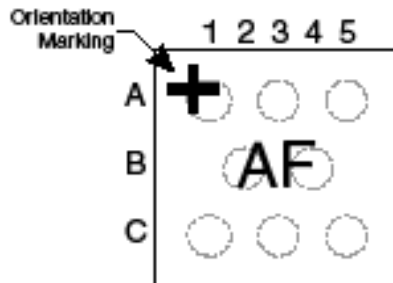

BOTTOM VIEW
(Bumps Up View)

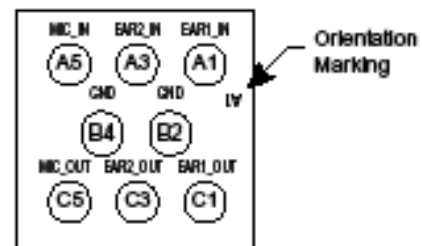

CSPEMI205
CSP Package

Note:

- 1) These drawings are not to scale.

CSPEMI205G

PIN DESCRIPTIONS

PIN	NAME	DESCRIPTION
A1	EAR1_IN	Earpiece Input 1 (from audio circuitry)
A3	EAR2_IN	Earpiece Input 2 (from audio circuitry)
A5	MIC_IN	Microphone Input (from microphone)
B2	GND	Device Ground
B4	GND	Device Ground
C1	EAR1_OUT	Earpiece Output 1 (to earpiece)
C3	EAR2_OUT	Earpiece Output 2 (to earpiece)
C5	MIC_OUT	Microphone Output (to audio circuitry)

Ordering Information

PART NUMBERING INFORMATION

Bumps	Package	Ordering Part Number ¹	Part Marking
8	CSP	CSPEMI205G	AF

Note 1: Parts are shipped in Tape & Reel form unless otherwise specified.

Specifications

ABSOLUTE MAXIMUM RATINGS

PARAMETER	RATING	UNITS
Storage Temperature Range	-65 to +150	°C
DC Power per Resistor	100	mW
DC Package Power Rating	300	mW

STANDARD OPERATING CONDITIONS

PARAMETER	RATING	UNITS
Operating Temperature Range	-40 to +85	°C

ELECTRICAL OPERATING CHARACTERISTICS (NOTE 1)

SYMBOL	PARAMETER	CONDITIONS	MIN	TYP	MAX	UNITS
R ₁	Resistance		9	10	11	Ω
R ₂	Resistance		54	68	75	Ω
C ₁	Capacitance		80	100	120	pF
C ₂	Capacitance		38	47	57	pF
I _{LEAK}	Diode Leakage Current	V _{IN} =5.0V			1.0	μA
V _{SIG}	Signal Voltage Positive Clamp Negative Clamp	I _{LOAD} = 10mA	5 -15	7 -10	15 -5	V V
V _{ESD}	In-system ESD Withstand Voltage a) Human Body Model, MIL-STD-883, Method 3015 b) Contact Discharge per IEC 61000-4-2 Level 4	Notes 2 and 4	±15 ±8			kV kV
V _{CL}	Clamping Voltage during ESD Discharge MIL-STD-883 (Method 3015), 8kV Positive Transients Negative Transients	Notes 2,3 and 4		+15 -19		V V
f _{C1}	Cut-off frequency 1; Note 5	R = 10Ω, C = 100pF		34		MHz
f _{C2}	Cut-off frequency 2; Note 5	R = 68Ω, C = 47pF		63		MHz

Note 1: T_A=25°C unless otherwise specified.

Note 2: ESD applied to input and output pins with respect to GND, one at a time.

Note 3: Clamping voltage is measured at the opposite side of the EMI filter to the ESD pin. For example, if ESD is applied to Pin A1, then clamping voltage is measured at Pin C1.

Note 4: Unused pins are left open.

Note 5: Z_{SOURCE}=50Ω, Z_{LOAD}=50Ω

Performance Information

Typical Filter Performance (nominal conditions unless specified otherwise, 50 Ohm Environment)

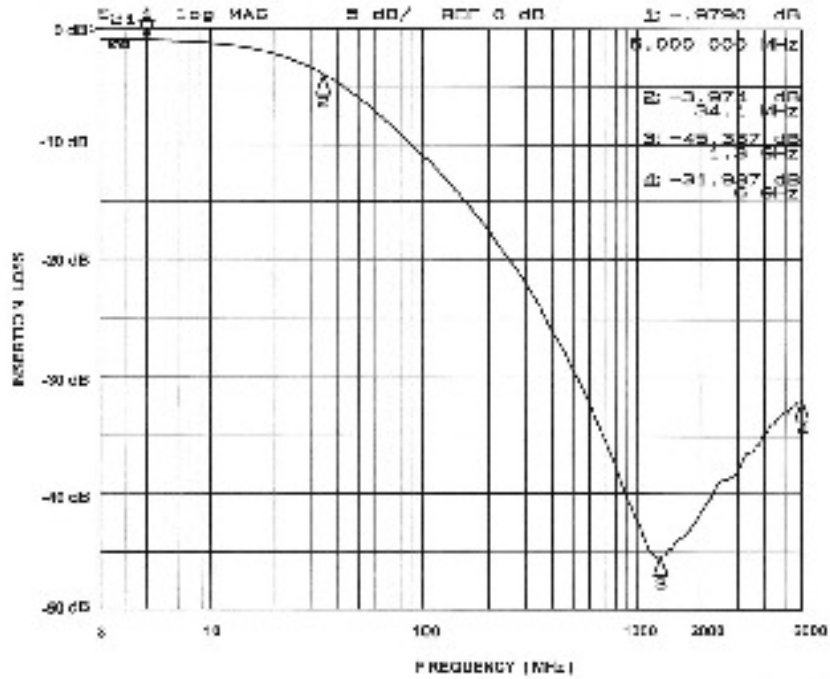

Figure 1. Earpiece Circuit (A1-C1) EMI Filter Performance

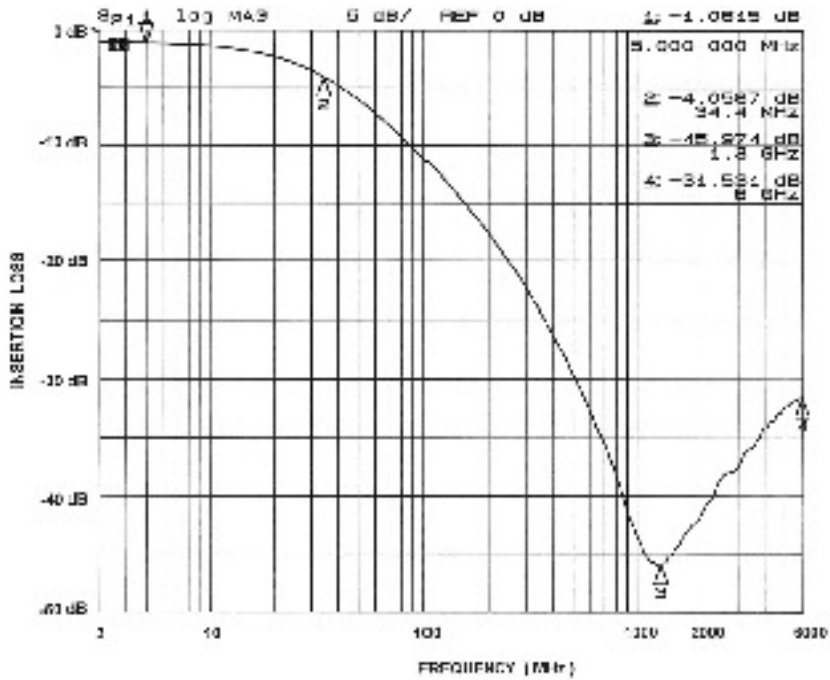

Figure 2. Earpiece Circuit (A3-C3) EMI Filter Performance

Performance Information (cont'd)

Typical Filter Performance (nominal conditions unless specified otherwise, 50 Ohm Environment)

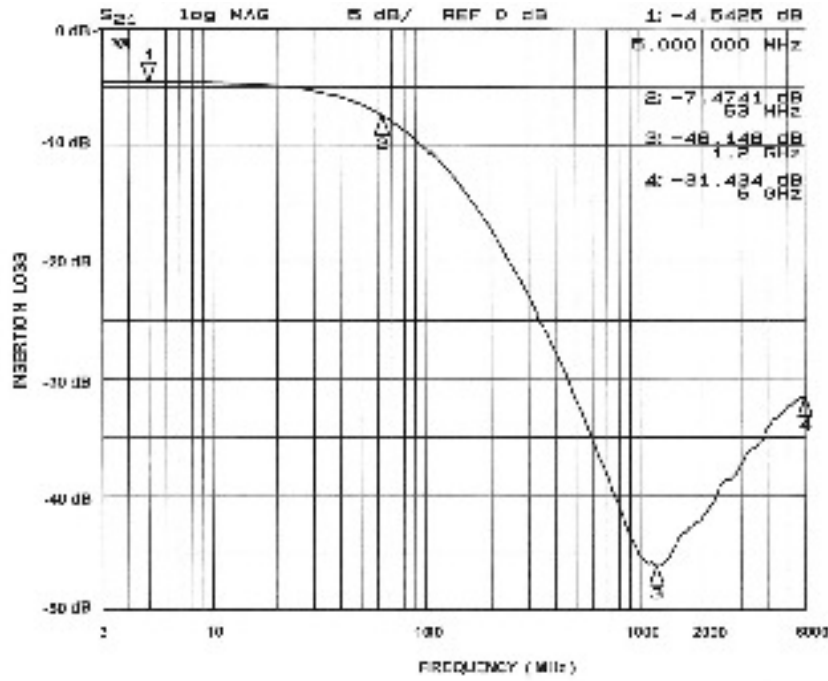

Figure 3. Microphone Circuit (A5-C5) EMI Filter Performance

Application Information

PARAMETER	VALUE
Pad Size on PCB	0.240mm
Pad Shape	Round
Pad Definition	Non-Solder Mask defined pads
Solder Mask Opening	0.290mm Round
Solder Stencil Thickness	0.125mm - 0.150mm
Solder Stencil Aperture Opening (laser cut, 5% tapered walls)	0.300mm Round
Solder Flux Ratio	50/50 by volume
Solder Paste Type	No Clean
Pad Protective Finish	OSP (Entek Cu Plus 106A)
Tolerance — Edge To Corner Ball	$\pm 50\mu\text{m}$
Solder Ball Side Coplanarity	$\pm 20\mu\text{m}$
Maximum Dwell Time Above Liquidous	60 seconds
Maximum Soldering Temperature for Lead-free Devices using a Lead-free Solder Paste	260°C

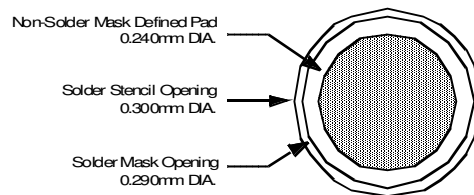

Figure 8. Recommended Non-Solder Mask Defined Pad Illustration

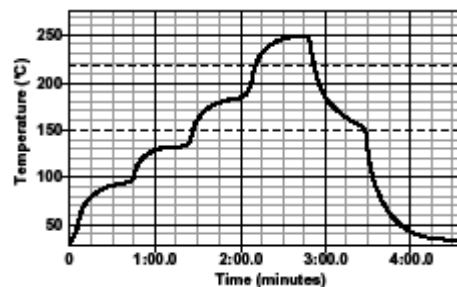

Figure 9. Lead-free (SnAgCu) Solder Ball Reflow Profile

Mechanical Details

CSP Mechanical Specifications

The CSPEMI205G is supplied in a custom Chip Scale Package (CSP). Dimensions are presented below. For complete information on CMD's chip scale packaging, see the California Micro Devices CSP Package Information document.

PACKAGE DIMENSIONS						
Package	Custom CSP					
Bumps	8					
Dim	Millimeters			Inches		
	Min	Nom	Max	Min	Nom	Max
A1	1.385	1.430	1.475	0.0545	0.0563	0.0581
A2	1.365	1.410	1.455	0.0537	0.0555	0.0573
B1	0.495	0.500	0.505	0.0195	0.0197	0.0199
B2	0.245	0.250	0.255	0.0096	0.0098	0.0100
B3	0.430	0.435	0.440	0.0169	0.0171	0.0173
B4	0.430	0.435	0.440	0.0169	0.0171	0.0173
C1	0.165	0.215	0.265	0.0065	0.0085	0.0104
C2	0.220	0.270	0.320	0.0087	0.0106	0.0126
D1	0.561	0.605	0.649	0.0221	0.0238	0.0256

D2	0.355	0.380	0.405	0.0140	0.0150	0.0160
# per tape and reel	3500 pieces					
Controlling dimension: millimeters						

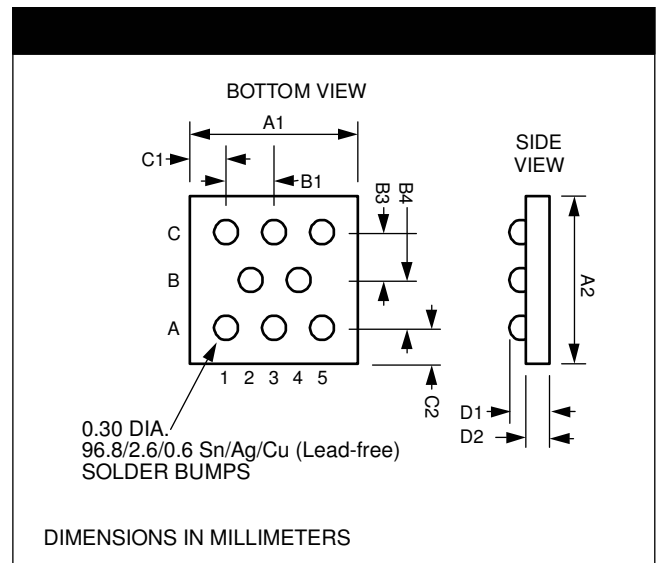

**Package Dimensions for CSPEMI205G
Chip Scale Package**

CSPEMI205G

CSP Tape and Reel Specifications

PART NUMBER	CHIP SIZE (mm)	POCKET SIZE (mm) $B_0 \times A_0 \times K_0$	TAPE WIDTH W	REEL DIAMETER	QTY PER REEL	P_0	P_1
CSPEMI205G	1.43 x 1.41 x 0.605	1.55 x 1.52 x 0.71	8mm	178mm (7")	3500	4mm	4mm

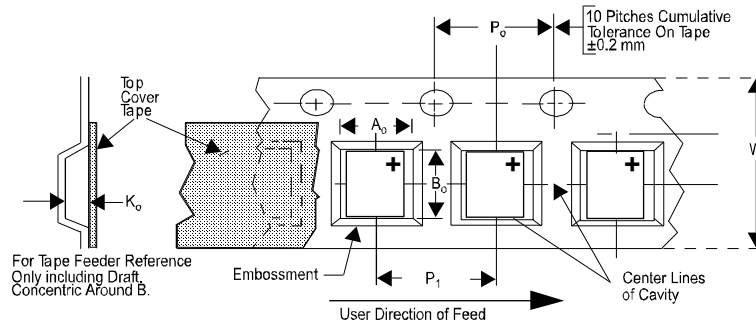



Figure 6. Tape and Reel Mechanical Data

ON Semiconductor and  are registered trademarks of Semiconductor Components Industries, LLC (SCILLC). SCILLC reserves the right to make changes without further notice to any products herein. SCILLC makes no warranty, representation or guarantee regarding the suitability of its products for any particular purpose, nor does SCILLC assume any liability arising out of the application or use of any product or circuit, and specifically disclaims any and all liability, including without limitation special, consequential or incidental damages. "Typical" parameters which may be provided in SCILLC data sheets and/or specifications can and do vary in different applications and actual performance may vary over time. All operating parameters, including "Typicals" must be validated for each customer application by customer's technical experts. SCILLC does not convey any license under its patent rights nor the rights of others. SCILLC products are not designed, intended, or authorized for use as components in systems intended for surgical implant into the body, or other applications intended to support or sustain life, or for any other application in which the failure of the SCILLC product could create a situation where personal injury or death may occur. Should Buyer purchase or use SCILLC products for any such unintended or unauthorized application, Buyer shall indemnify and hold SCILLC and its officers, employees, subsidiaries, affiliates, and distributors harmless against all claims, costs, damages, and expenses, and reasonable attorney fees arising out of, directly or indirectly, any claim of personal injury or death associated with such unintended or unauthorized use, even if such claim alleges that SCILLC was negligent regarding the design or manufacture of the part. SCILLC is an Equal Opportunity/Affirmative Action Employer. This literature is subject to all applicable copyright laws and is not for resale in any manner.

PUBLICATION ORDERING INFORMATION

LITERATURE FULFILLMENT:
Literature Distribution Center for ON Semiconductor
P.O. Box 5163, Denver, Colorado 80217 USA
Phone: 303-675-2175 or 800-344-3860 Toll Free USA/Canada
Fax: 303-675-2176 or 800-344-3867 Toll Free USA/Canada
Email: orderlit@onsemi.com

N. American Technical Support: 800-282-9855
Toll Free USA/Canada
Europe, Middle East and Africa Technical Support:
Phone: 421 33 790 2910
Japan Customer Focus Center
Phone: 81-3-5773-3850

ON Semiconductor website: www.onsemi.com
Order Literature: <http://www.onsemi.com/orderlit>
For additional information, please contact your local Sales Representative